



ABN 30 364 773 907

Curved Plywood Specialists

13 -15 Leah Grove,
Carrum Downs VIC, 3201.
Australia.

Tel: 61 3 9775 1663

Fax: 61 3 9775 1994

enq@slorachdesigns.com.au

www.slorachdesigns.com.au

No. 41

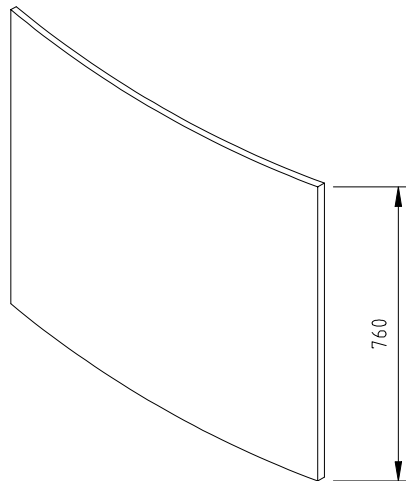
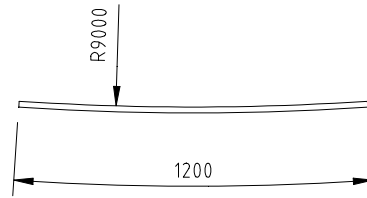

SPECIFICATIONS CABINET DOOR

TOTAL THICKNESS :-	18mm.
NUMBER OF LAMINATIONS :-	-
ADHESIVE :-	UREA FORMALDEHYDE GRASP CR560.
CURING METHOD:-	RADIO FREQUENCY.